

## AN UPDATE ON PTB'S ACTIVITIES IN TIME AND FREQUENCY

**D. Piester, A. Bauch, J. Becker, and T. Polewka**  
**Physikalisch-Technische Bundesanstalt, Braunschweig, Germany**

### Abstract

*Recent activities in the field of time and frequency pursued at PTB were directed towards an improvement in quality and reliability of services offered by PTB. The infrastructure for realizing the time scale UTC (PTB) and the monitoring of PTB's time services was modernized. Several calibration exercises were conducted which resulted in an improved knowledge of internal delays of PTB's time comparison equipment. As the foundation of our work, we continued the operation of the primary clocks CS1 and CS2, and of the cold-atom cesium fountain CSF1.*

### INTRODUCTION

Basically, there have been no changes of the mission and the general tasks of the Time and Frequency Department of the Physikalisch-Technische Bundesanstalt PTB. The work, however, is now performed in so-called Working Groups (WG). Their detailed tasks and staffing shall be evaluated every 5 years [1].

In this contribution we give a brief report on the activities related to:

- operation of PTB's atomic clock ensemble,
- realization of UTC (PTB), and
- calibration of PTB's time links,

which are performed in the Time Standards WG and the Time and Frequency Dissemination WG. These activities were stimulated in part by new requirements coming up, since PTB has become part of the experimental ground infrastructure of the Galileo System Testbed GSTB-V1. A geodetic time-oriented GPS receiver was installed at PTB, as part of the GSTB Sensor Station network. It shall be used for providing a time link between the Experimental Precision Timing Station (E-PTS) maintained at Istituto Elettrotecnico Nazionale Galileo Ferraris (IEN) and PTB through the Orbit Determination and Time Synchronization (ODTS) process, in parallel with existing standard time comparison links between the two institutes. Thereby, a part of the ODTS procedures shall be validated. It was required that both geodetic GPS receivers (the new one, acronymed PTBG, and PTBB, which is provided by Bundesamt für Kartographie und Geodäsie [BKG] and which is included in the network of the International GPS Service for Geodynamics [IGS], and also the Two-Way Satellite Time and Frequency Transfer [TWSTFT] station used for comparisons among European laboratories) be connected to the same physical realization of UTC (PTB) with known and stable delays. Without changes, this would have required collection and transmission of additional data in nonstandard procedures.

In these Proceedings, we report separately on the evaluation of the time transfer links between PTB and the United States Naval Observatory (USNO) [2]. The GSTB activities were addressed in detail in a contribution to GNSS2003 [3].

## CLOCK OPERATION

PTB currently provides data from three PTB-built clocks with a thermal atomic beam, CS1, CS2, and CS3 (which is no longer evaluated as a primary clock), three commercial cesium clocks, and two active hydrogen masers as inputs to the calculation of the free atomic time scale EAL (Echelle atomique libre) by the International Bureau of Weights and Measures (BIPM) in the latter's ALGOS procedure [4]. The statistical weights that these clocks got during the last 12 months are depicted in Figure 1. Even at the presumably appropriate environmental conditions (temperature 23.6°C, variations within 0.4°C peak-to-peak, except during 7 days in 2003, relative humidity bounded between 50% and 75%), the commercial clocks do not all get a large weight, whereas other clocks of the same kind in other institutes do [4]. It would be interesting to understand whether the clock behavior is triggered by laboratory activities external to the clocks or by effects intrinsic to the devices and, thus, out of our control. A partial blocking of the cesium atomic beam in CS1 caused a decrease in the clock's signal-to-noise ratio, leading to an increased frequency instability, and this may have caused the reduced weight during the last months. The problem was remedied.

The fountain clock CSF1 was operated sequentially in a variety of operation modes throughout the year, including different atom numbers, microwave excitation level and tilt from the ideal vertical. We aimed at the confirmation of the previous uncertainty estimate [5] and, in particular, to exclude the existence of significant frequency shifts related with the spatial distribution of phase of the microwave field in the cavity. The team of BNM SYRTE had reported on frequency shifts occurring when their fountains were tilted away from the vertical and, at the same time, the microwave field amplitude with which the atoms are irradiated was increased by factors of 3 to 9 [6]. Studies of the same kind with the CSF1 have not given a clear picture yet. They were strongly hampered by an unusual frequency instability of the hydrogen masers, serving as intermediate flywheels over periods of several days during such studies. Here we give only a cursory summary of our observations. The lowest achievable statistical uncertainty of frequency measurements was between 1 and 2 parts in  $10^{15}$  due to the flicker noise that we attribute to the masers. In view of this, the frequency shift of about  $4 \cdot 10^{-15}$ , observed when the microwave field amplitude in CSF1 was set a factor of 3 above optimum ( $\pi/2$  excitation), may be called significant. Only insignificant shifts were observed when the field strength was raised by a factor of 5. No dependence on the tilt angle could be observed. We decided to postpone further studies of this kind until more stable references are available in the laboratory. In Figure 2, the frequency comparison results obtained during 2003 are depicted. Each data point (322 in total) represents an average over at least 10 hours of CSF1 operation. No distinction was made in the plots of the CSF1 operation conditions prevailing when the data were taken. All maser frequency changes are to our knowledge "spontaneous," i.e. not triggered by human activity.

## REALIZATION OF UTC (PTB)

The realization of UTC (PTB) has undergone a modernization process that is not completed at the time of this writing. The old situation is depicted in the upper part of Figure 3. The time transfer equipment was installed in different rooms, and the reference signals "UTC (PTB)" were derived from different hardware components. Monitoring the delays between different signal outputs revealed occasional wander by as

much as 2 ns peak-to-peak. No such problem should exist in the new setup, depicted in the lower part of Figure 3, which is to a large extent installed in the refurbished central measurement room. The room is kept at 23.0°C, and peak-to-peak temperature excursions did not exceed 0.4°C since the system started working in the spring of 2003. The new phase microstepper (PMS, model SDI HROG-5) generating the UTC (PTB) frequency allows frequency steering under PC control, and it is capable of providing an output signal with typical hydrogen maser stability. Because of the current problems with the masers, UTC (PTB) remains for the moment based on the CS2 frequency. In addition, the old equipment is remaining in operation in the clock hall as a backup. Mutual monitoring of the two UTC (PTB) signals and alarming in case of detected anomalies have been established.

## CALIBRATION OF TIME LINKS

In the frame of establishing a formal collaboration between IEN, which houses the GSTB E-PTS, and PTB, which primarily provides the link to UTC through its locally realized UTC (PTB), the primary time link using TWSTFT in the Ku-band between both institutes was calibrated. In the future, the “true” time differences obtained thereby shall be compared with the time differences produced in the GSTB ODS procedures under test.

We take this opportunity to recall the principle of the experiment performed and explain the observations, but will not recall the principles of TWSTFT in more detail [7, 8]. On a contract basis, a travelling TWSTFT station, named TUG02, was provided and operated at PTB and at IEN by Joanneum Research, Graz, Austria [9]. The two setups that were realized in sequence are depicted in Figure 4. At each site, the TUG02 station was operated during the standard TWSTFT sessions (between 14:00 and 15:00 UTC each working day), but several additional sessions were performed. At both sites, the time differences Local Station (LS) minus TUG02 were determined in the direct mode. Additionally, TWSTFT to the remote site was performed, which allowed the determination of nominally the same time differences in an indirect mode, based on another set of data. The results are shown in Figure 5. TUG02 was operated at IEN on Modified Julian Dates (MJDs) 52789 and 52790 and, after having returned from PTB, again on 52796, June 2<sup>nd</sup>, 2003. At PTB, data were taken on MJDs 52792 and 52793.

To be more specific, each data point labeled as “direct” is the outcome of two kinds of measurements done at each site:

- a time difference measurement of the received signal (RX) with respect to the local reference, and
- a time interval measurement of the transmit signal (TX) with respect to the local reference, here UTC (k).

Data treatment followed the routines prescribed in [7, 8], i.e. a quadratic fit was done to the nominally 120 individual measurements, and the midpoint (second #61) was reported, together with the standard deviation. The combined measurement uncertainty for an individual point was about 0.3 ns. One notices that the standard deviation of the 14 data points taken at IEN in total is 0.7 ns and, thus, larger. The same is true even if one restricts to the data taken at the first 2 days. The statistical uncertainty for each point labeled “indirect” is expected to be larger by at least a factor  $\sqrt{2}$ , since a second noisy RX measurement is involved. Even when this is taken into account, it would not explain why direct and indirect measurements differ to the extent shown in the figure.

Figure 6 summarizes the results in terms of the CALR value, to be applied when evaluating the PTB-IEN TWSTFT link further on [8]. The combined calibration uncertainty is, thus, below 1 ns, as initially aimed at. In the future, similar campaigns may include other stations in Europe and the US. We propose to

make use of the capability of the new generation of SATRE modems to exchange data in the PRN signal during the session, allowing a preliminary evaluation of the results to be made almost in real time.

Only a few weeks after this calibration exercise, the use of the Intelsat satellite 706, used successfully for many years, had to be abandoned, since the satellite did no longer provide the required interconnectivity between Europe and the US. TWSTFT has been continued using satellite Intelsat 903 at position 34° 50' W. At PTB, this required changes in the downlink equipment for accommodation with the downlink frequency of the Europe-Europe transponder. A similar hardware configuration had been used up to April 2001. The switch to the new satellite and the hardware modifications were performed on MJD 52898 during working hours. TWSTFT comparisons between IEN and PTB were performed immediately before and afterwards. In addition, TWSTFT comparisons were performed with VSL, where G. de Jong determined the Earth Station Delay Variations (ESDVAR [8]) of the VSL station as only 0.2 ns (private communication). These measurements allowed the *a priori* unknown change of the ESDVAR of the PTB equipment to be determined. Due to the change of the geometry of the triangle made up of IEN, PTB, and the satellite, the Sagnac correction changes by -5.858 ns for the time comparison PTB minus IEN [8, 10]. The continuing time comparisons between IEN and PTB using geodetic GPS receivers and evaluation of the time differences in the TAIP3 mode [11, 12] provided a second opportunity to determine the delay changes.

In Figure 7, the measurement results and adjustments of delays are illustrated. We consider the time difference between hydrogen maser H2 of PTB and UTC (IEN). The GPS data, one measurement every 16 minutes, 4 to 6 satellites in common view, are depicted with full circles. The data were adjusted to the TWSTFT data (open triangles) collected before the satellite change (dashed vertical line) in the following way. A linear regression was performed to 11 GPS data collected around the TWSTFT epoch and the difference of the midpoint to the corresponding TWSTFT data was determined. The sum of the squared differences between TWSTFT and such GPS means was minimized. The simplest procedure was to adjust the TWSTFT data after the satellite change to the GPS data in the same way. Taking the Sagnac correction into account, one derives a change of ESDVAR (PTB) of 61.2 ns. The more sophisticated approach neglects GPS measurements, and includes instead three-cornered comparisons IEN-VSL-PTB, which were performed around the date of the satellite change, taking the measured ESDVAR (VSL) change into account. The result is depicted as open circles in Figure 7. The ESDVAR (PTB) change of 64.6 ns derived therefrom is slightly larger than the above value, but not too different in view of the uncertainty of the latter procedure of about 2 ns. A more detailed discussion of the impact of the satellite changes has been announced for the EFTF 2004.

A slightly different philosophy is behind the calibration exercises that were performed by USNO. As depicted in Figure 8, a so-called fly-away station is operated initially and after the calibration trip at USNO connected to the same clock as the standard TWSTFT equipment, giving the station calibration value. Assuming that the internal delays of the travelling station remain unchanged when the station is operated at PTB, the true time difference UTC (USNO) – UTC (PTB) is determined, combining the results obtained at PTB with the station calibration value. Such an exercise does not require the regular operation of a USNO-PTB link using the same technology and satellite. Results of recent calibrations are included in Piester *et al.* [2].

## OUTLOOK

We have firm plans to continue the development of atomic frequency standards and their application in the realization of PTB's atomic time scales. Both kinds of activities are dependent on each other. The second cold-atom fountain should deliver first signals in 2004 and later serve as frequency reference for

studies made with CSF1. The PTB has just started to provide data from a new GPS multi-channel receiver. We expect that the use of a multiplicity of links among the important timing centers will favor the comparison of fountains with an uncertainty of  $1 \cdot 10^{-15}$  in the future.

## ACKNOWLEDGMENTS

The authors appreciate the stimulating collaboration with Hubert Ressler, Otto Koudelka, Bernd Blanzano, and Christian Karel of Joanneum Research, Graz, Luca Lorini and Franco Cordara of IEN, Angela McKinley, Alan Smith, Eric Newman, Paul Wheeler, and Demetrios Matsakis of USNO, which was substantial for what has been achieved and what is reported here. We are particularly grateful to Gerrit de Jong of NMi Van Swinden Laboratory, Delft, the Netherlands, who rapidly provided the actual Sagnac corrections for all combinations of TWSTFT links. CSF1 was operated by Stefan Weyers and Robert Wynands, and the clock monitoring was at hands of Christof Richter, all of PTB. Their support is appreciated. The TWSTFT calibration cost was sustained by IEN in the frame of the GSTBV1 contract with ESA.

## DISCLAIMER

The Physikalisch-Technische Bundesanstalt as a matter of policy does not endorse any commercial product. The mentioning of brands and individual models seems justified here, because all information provided is based on publicly available material or data taken at PTB and it will help the reader to make comparisons with his own observations.

## REFERENCES

- [1] [http://www.ptb.de/en/org/4/44/\\_index.htm](http://www.ptb.de/en/org/4/44/_index.htm).
- [2] D. Piester, A. Bauch, J. Becker, T. Polewka, D. Matsakis, and A. Mc Kinley, 2004, “*Time Transfer Between USNO and PTB: Operation and Calibration Results*,” in these Proceedings, pp. 93-102.
- [3] G. Graglia, E. Detoma, F. Cordara, R. Costa, L. Lorini, D. Orgiazzi, V. Pettiti, P. Tavella, and J. Hahn, 2003, “*The Experimental Precise Timing Station and the Galileo System Time generation in the Galileo System Test Bed Phase VI*,” in Proceedings of the Global Navigation Satellite Systems (GNSS) Conference 2003, published on CD-ROM.
- [4] C. Thomas and J. Azoubib, 1996, “*TAI computation: study of an alternative choice for implementing an upper limit of clock weights*,” **Metrologia**, **33**, 227-240 (see [http://www1.bipm.org/en/scientific/tai/time\\_ftp.html](http://www1.bipm.org/en/scientific/tai/time_ftp.html) for the data files containing clock weights and rates).
- [5] S. Weyers, A. Bauch, R. Schröder, and C. Tamm, 2002, “*The atomic caesium fountain CSF1 of PTB*,” in Proceedings of the 6<sup>th</sup> Symposium on Frequency Standards and Metrology, 9-14 September 2001, St. Andrews, Scotland, UK, pp. 64-71.
- [6] M. Abgrall, 2003, “*Evaluation des performances de la fontaine atomique PHARAO, Participation à l'étude de l'horloge spatiale PHARAO*,” thesis, University Paris VI (unpublished).

- [7] D. Kirchner, 1999, “*Two-way Satellite Time and Frequency Transfer (TWSTFT): Principle, Implementation, and Current Performance*,” **Review of Radio Sciences 1996-1999** (Oxford University Press), pp. 27-44.
- [8] Recommendation ITU-R TF.1153-1 “*The operational use of two-way satellite time and frequency transfer employing PN time codes*,” ITU, Radiocommunication Study Group, Geneva, last update 2003.
- [9] H. Ressler, O. Koudelka, B. Blanzano, and C. Karel, 2003, “*Two-Way Satellite-Time-Transfer Calibration Campaign*,” Report IAS.2002.AF.012-01, Joanneum Research, June 2003 (unpublished).
- [10] G. deJong, VSL, Delft, the Netherlands, private communication, October 2003.
- [11] G. Petit, Z. Jiang, and P. Moussay, 2003, “*TAI time links with geodetic receivers: A progress report*,” in Proceedings of the 34<sup>th</sup> Precise Time and Time Interval (PTTI) Systems and Applications Meeting, 3-5 December 2002, Reston, Virginia, USA (U.S. Naval Observatory, Washington, D.C.), pp. 19-28.
- [12] P. Defraigne and G. Petit, 2003, “*Time transfer to TAI using geodetic receivers*,” **Metrologia**, **40**, 184-188.

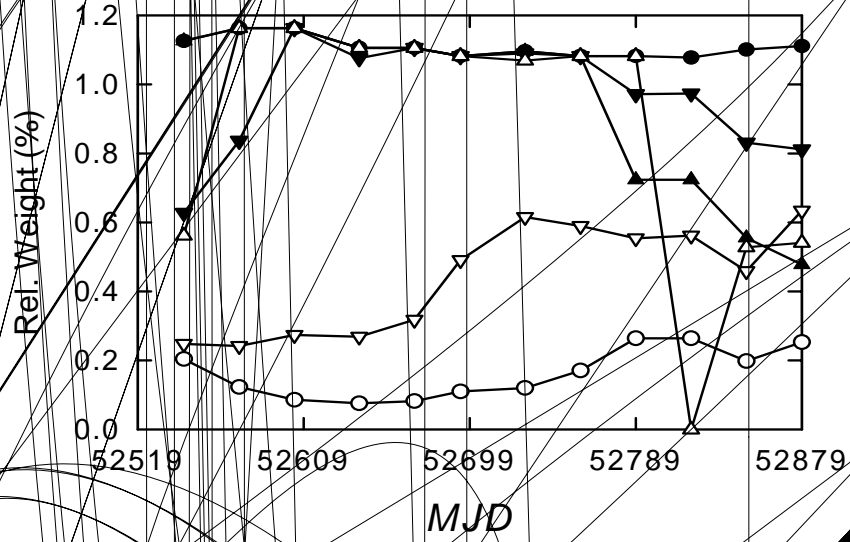

Figure 1. Statistical weights of PTB's clocks, as obtained in the ALGOS procedure on the Echelle Atomique Libre at BIPM; data taken from files w03.02 (<ftp://62.161.69.5/pub/taipublication/>, access see [4]). Full symbols designate the clocks of type 35 (Agilent 5071A): ●: CS2, ▼: CS3, open symbols designate clocks of type 35 (Agilent 5071A) with serial numbers: ▽: 128, ○: 415, △: 1072.

280

270  
260  
250

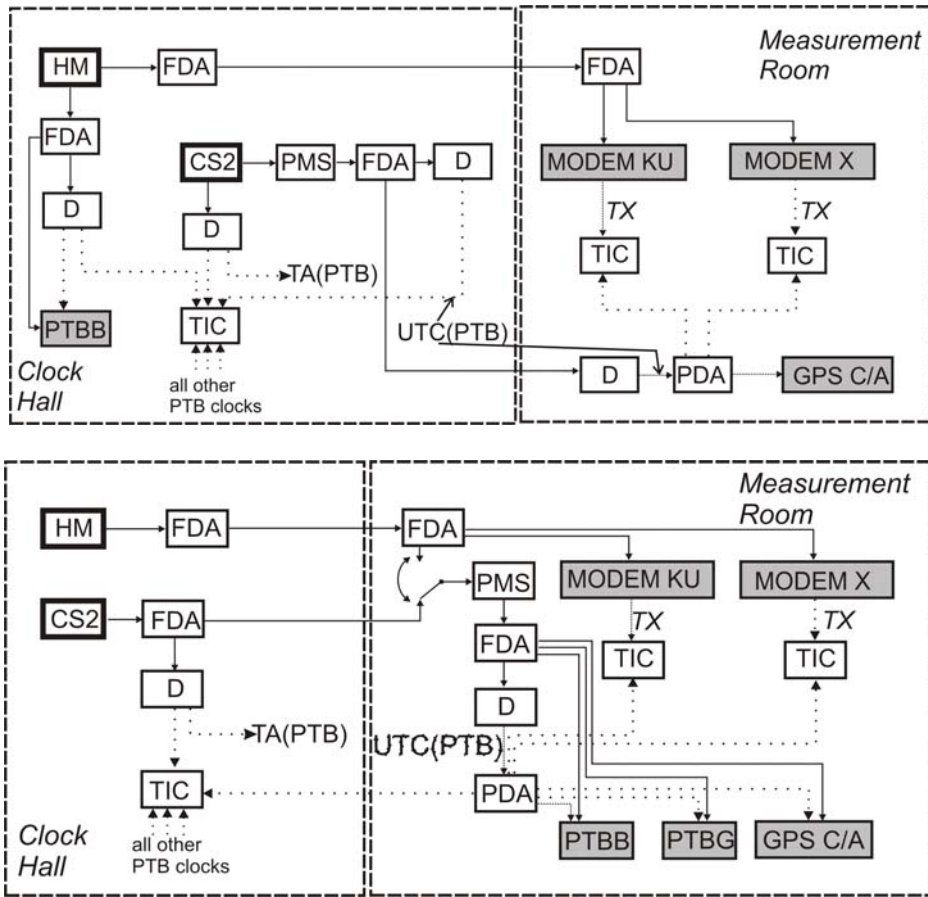

Figure 3. Realization of UTC (PTB); upper graph: arrangement in service until September 2003, lower graph: new arrangement. HM: hydrogen maser, FDA: frequency distribution amplifier, D: divider delivering 1 PPS signals, TIC: time interval counter, PDA: pulse distribution system, PMS: phase micro stepper. Solid lines: 5 MHz signals, dotted lines: 1 PPS signals, gray boxes: time transfer equipment, mentioned in the text. Frequency converters (e.g. 5 MHz to 10 MHz or 20 MHz) are not shown.

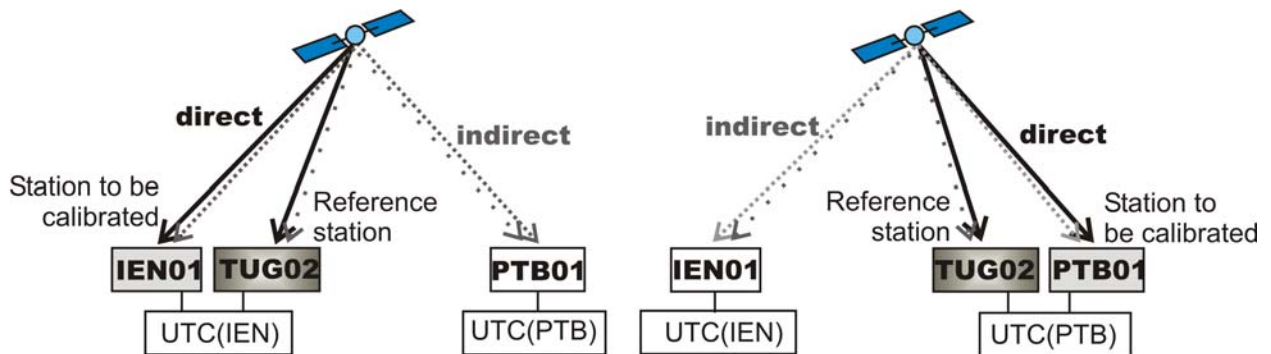

Figure 4. Schematic representation of the setup of a travelling TWSTFT station sequentially at IEN, Torino, and PTB. The TWSTFT stations are given as gray shaded squares. The solid arrows represent the direct time transfer performed during the measurement campaigns. The dashed arrows indicate the additionally evaluated links that give so-called indirect results.



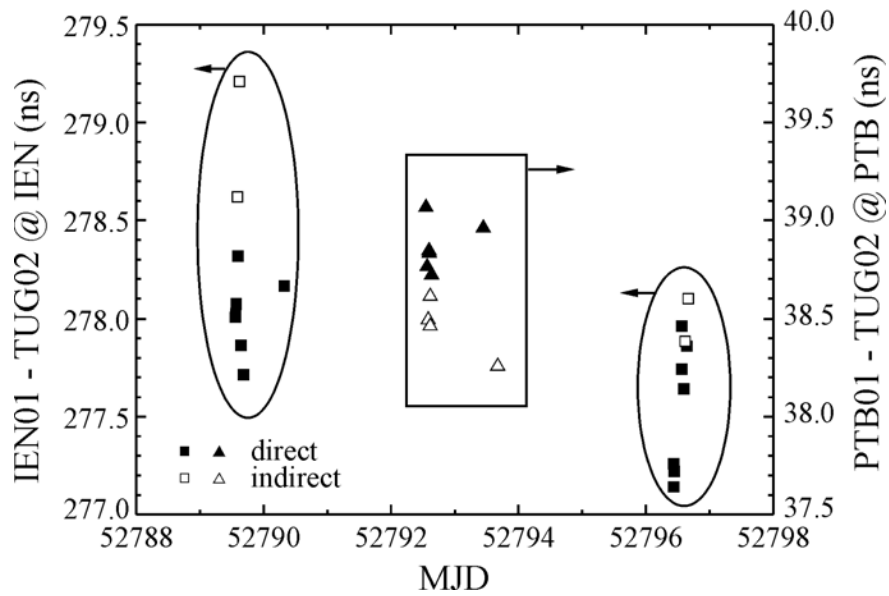

Figure 5. Results of differential delay measurements of the pairs of TWSTFT stations IEN01, PTB01 and TUG02, operated in sequence at IEN (labeled IEN01-TUG02, left axis, squares) and PTB (labeled PTB01-TUG02, right axis, triangles), as explained in the text. Full symbols: direct measurement, open symbols: indirect measurements (see Fig. 4 for explanation). Data were taken from [9].

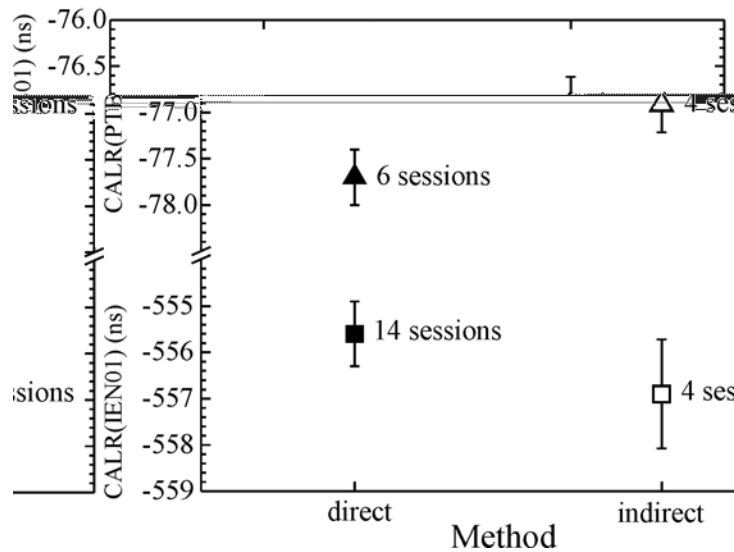

Figure 6. Final result of the IEN-PTB calibration exercise [9] in terms of the CALR value [8]. The error bars represent the  $1\sigma$  standard deviation of the individual data from the respective mean. The symbol code is as in Figure 5.

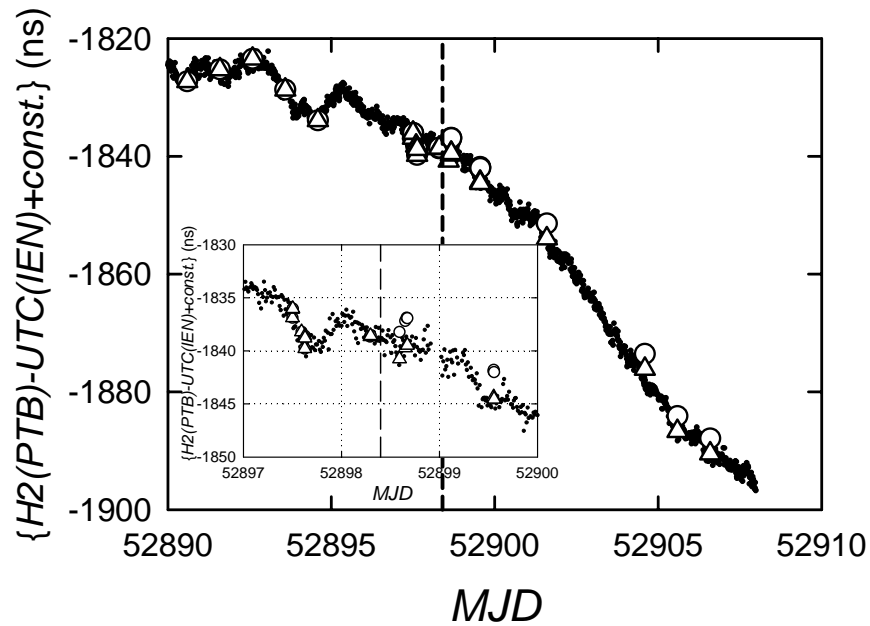

Figure 7. Time comparisons between hydrogen maser H2 at PTB and UTC (IEN); dots: GPS comparisons in the TAIP3 experiment using geodetic receivers, open symbols: TWSTFT using Intelsat 706 up to the date indicated by the vertical dashed line, and Intelsat 903 thereafter. ( $\Delta$ ): data adjusted to the GPS measurements, (O): calculated based on evaluation of the links IEN-VSL, IEN-PTB and VSL-PTB.

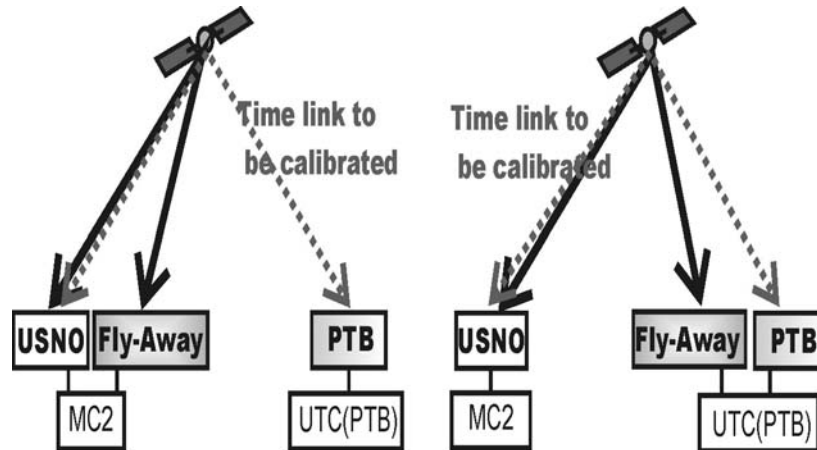

Figure 8. Schematic representation of the setup of a travelling TWSTFT station sequentially at USNO and PTB. The stations are given as gray shaded squares. The solid arrows indicate the time transfer performed during the measurement campaigns. The dashed lines indicate time transfer links that can in principle be calibrated that way.